



TO PLACE AN ORDER CALL: 866-487-4751
OR VISIT: WWW.TIMECLOCKEXPERTS.COM

CALCULATING TIME RECORDER

USER'S MANUAL





TO PLACE AN ORDER CALL: 866-487-4751
OR VISIT: WWW.TIMECLOCKEXPERTS.COM

TABLE OF CONTENTS

1. INTRODUCTION.....	1
2. FEATURES	2
3. PREPARATION.....	3
(1) Structure	3
(2) Installation.....	4
4. DAILY OPERATION	5
5. QUICK EASY SETUP	6
6. SETTING THE TIME.....	7
7. SETTING THE DATE.....	8
8. SETTING TIME SYSTEM.....	9
9. SETTING PRINT FORMAT.....	10~14
10. SETTING THE TIME OF DAY CHANGE.....	15
11. SETTING THE COMMON SCHEDULE.....	16~23
12. SETTING THE EXTRA SCHEDULE.....	24~34
13. SETTING THE ROUNDING PUNCH.....	35~36
14. SETTING THE DAYLIGHT SAVING TIME.....	37~40
15. SETTING THE PRINT LANGUAGE.....	41
16. SETTING THE BUZZER PERIOD.....	42
17. SETTING THE VERTICAL ADJUST	43
18. TIME CARD NUMBER TRANSFER.....	44
19. TIME CARD NUMBER DELETE.....	45
20. PRINT SAMPLE.....	46~49
21. RESET.....	50
22. REPLACING THE RIBBON CARTRIDGE.....	51
23. CONNECTING THE EXTERNAL TIME SIGNAL (OPTIONAL).....	52
24. INSTALLING THE BATTERY PACK (OPTIONAL).....	53
25. TROUBLESHOOTING.....	54



TO PLACE AN ORDER CALL: 866-487-4751
OR VISIT: WWW.TIMECLOCKEXPERTS.COM

1. INTRODUCTION

1. The details of this User's Manual are subject to change without prior notification.
2. This User's Manual has been prepared with the utmost care to cover all aspects of the time recorder's use. However, if there are some explanations that are inadequate, unclear, or difficult to understand, please do not hesitate to contact the dealer or the store from which you have purchased your Time Recorder.
3. Be sure to use your Time Recorder after you have fully understood the hardware, software specifications and limits.

SPECIFICATIONS

- Power Supply: AC 100V~240V 50/60Hz
- Power Consumption: Normal 0.8W (Max.15W)
- Standard time signal: Quartz oscillation
- Clock accuracy: Monthly accuracy ± 15 sec. (at ordinary temperatures)
- Printing system: Dot matrix.
- Power failure compensation: Three years of cumulative power failure hours after the date of shipment.
- Print at power failure: Optional battery pack, 200-time printing or 24 hours.
- Operating environment: Temperature: -5°C to 45°C , 23°F to 113°F .
Humidity: 20% to 80% (no condensation).
The unit operates normally at temperatures of 5°C or below, but the print density, reaction of the LCD display, and the numbers of prints are inferior to those at normal operation temperature.
- Dimensions: 7.91" (H) X 6.02" (W) X 4.64" (D)
201mm (H) X 153mm (W) X 118mm (D)
- Weight: Approx, 3.1 lbs. (1.4Kg)
- Accessories: Operation manual: 1 copy
Fuses: 1 pc. Keys: 2 pcs.



TO PLACE AN ORDER CALL: 866-487-4751
OR VISIT: WWW.TIMECLOCKEXPERTS.COM

2. FEATURES

- This unit has two work type that can be selected (employee and part-time).
- This unit has the ability to calculate elapsed time between IN/OUT punches.
There are two calculation mode, (punch and hourly) that can be selected.
- In Employee mode, you can punch IN/OUT as many times as required per day.
- Automatic IN/OUT column shift when you punch.
- In Employee mode, you can select one of three pay period:
Monthly/ Weekly/ Bi-Weekly.
- Two types of schedules can be programmed:
Common schedule/ Extra schedule.
- A maximum of 50 cards can be automatically registered.
- Special mark printing can be set to make it easy to track employee's, late in or early out.
- The language of English, Spanish, Germany, French, Italian, Portuguese can be selected to print the day of the week.
- **Security for power failure**
 - (1) Optional battery pack ensures full printing operation after power failure.
 - (2) When the battery voltage drops too low for a print to be produced, the LCD display goes out. Both time and programs are retained by a lithium battery for approx. 36 months.
 - (3) After power is restored, the time recorder will automatically advance to the present time.
- **Midnight button**

For nightshift workers, when punch time is over the printing line time, press the "Midnight button" then punch the time card. The time will be entered in the "OUT" column of the previous day.

* On pay ending day, the "Midnight button" will be of no use.
- **Time display**

Easy-to-read, back light L.C.D. It shows date, AM/PM (when set to 12-hour system), time, day of week and other codes.
- **Automatic Day Light Saving Time**

3. PREPARATION

(1) Structure

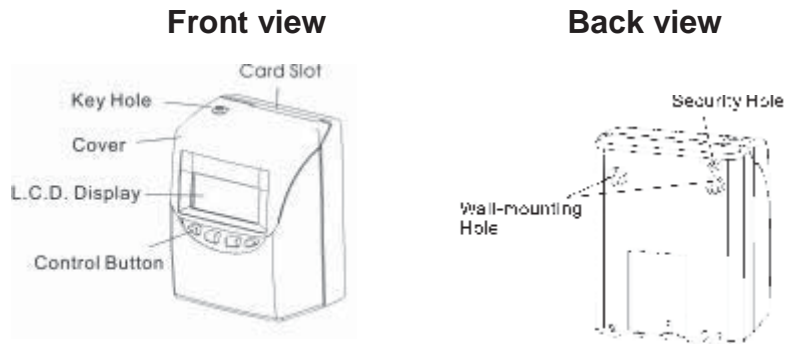

Display



(2) Installation

●Power Source

- 1) Use a power source with a stable voltage.
- 2) Use a power source which is independent from other equipment.

●Installation

Avoiding installing the machine in any of the following places:

- 1) Subject to high humidity and dust.
- 2) Exposed to strong or continuous vibrations.
- 3) Exposed to direct sunlight.

“CAUTION”: DISCONNECT POWER SUPPLY CORD BEFORE
OPENING HOUSING.

“WARNING”: EXPLOSING HAZARD - DO NOT USE
NON-RECHARGABLE BATTERIES.

(3) Wall Mounting

- 1) Place 2 screws into a wall 3.94 inches (10cm) apart. Be sure to keep approx. 0.12 inch (3mm) of the screw head protruding from the wall.
- 2) Hook the unit on to the screws through the holes of the back cover, as shown in the figure.

* Please note position of security hole (located above the left fixing hole).

Installation: Remove lid, mark position of hole onto the wall, remove machine, drill, fit wall plug, refit machine to wall, enter security screw into position and replace lid.

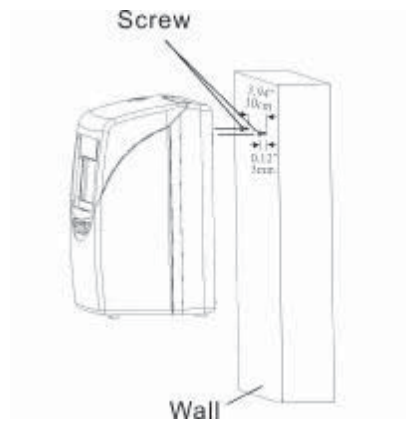

4. DAILY OPERATIONS

- When the power cord is plugged in, the time recorder can be used immediately with the basic functions. The basic functions include the work type (employee), pay period (monthly) and pay ending day (31).
- In employee mode, when a new time card is inserted to the time recorder, the time card will be registered automatically, and will print in "IN" position on the first line.
- In employee mode, you can punch "IN" and "OUT" as many times as you want per day, the time recorder will memorize the last punch, and automatically switch to "IN" or "OUT" position.
- You can change the "IN" or "OUT" position by pressing the "IN" or "OUT" button.
- If punched in "OUT" position when the work time is over the "printing line time", by pressing the "midnight button" and then making a punch, it will imprint "IN" and "OUT" on same printing line, otherwise the imprint will be in the "IN" position on the next printing line.

***On pay ending day, the "Midnight button" can not be used.**



5. QUICK EASY SETUP

- (1) Plug the Ac cord into the Ac outlet.

*The socket-outlet should be installed near the equipment and should be easily accessible.

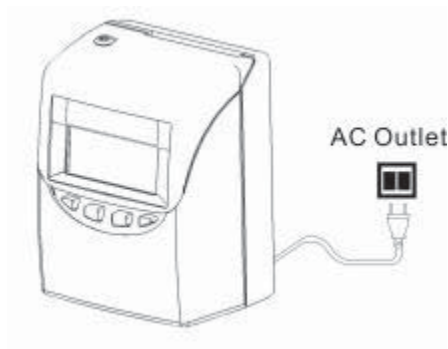

- (2) Remove the protection pad.



- (3) Unlock with key and remove the top cover.



- (4) When program settings are completed, replace the top cover and lock.

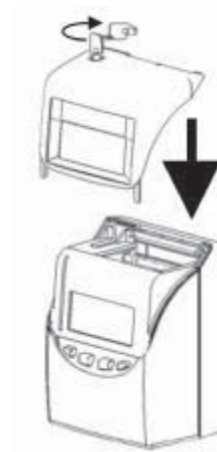

6. SETTING THE TIME

Example: Change the time from PM 10:20 to AM 11:30

- (1) Press the [F] button, and position the “▲” under the “TIME” mark. The “Hour” flashes (The flashing means it can be changed).

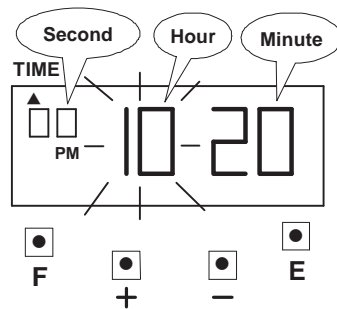

Setting the “Hour”

Press the [+] or [-] button to set at “AM 11” and press [E] button. At the same time, the flashing changes from “Hour” to “Minute”.

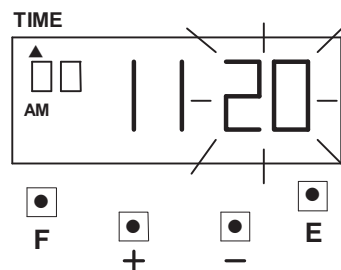

- (2) **Setting the “Minute”**
Press the [+] or [-] button to set at “30” and press [E] button.

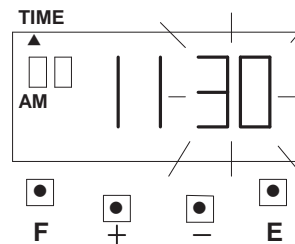

At the same time, the “Second” starts to run from “00” and the LCD screen only display “▲” under the “TIME” mark.

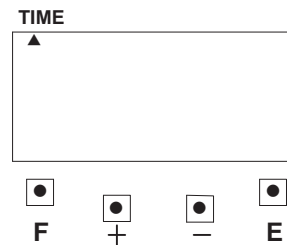

- (3) If you want to set another function, press the [F] button to continue setting. If you finished setting the functions, replace the cover and lock it.

7. SETTING THE DATE

Example: Change the Date from January 1, 2006 to June 10, 2006.

- (1) Press the [F] button, and position the “▲” under the “DATE” mark. The “Year” flashes (The flashing means it can be changed).

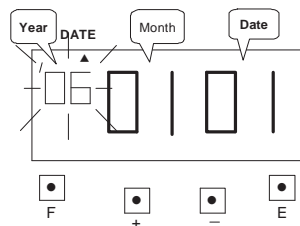

Setting the year

Such as example, press the [E] button because the year 2006 is not to be changed. At the same time, the flashing changes from “Year” to “Month”.

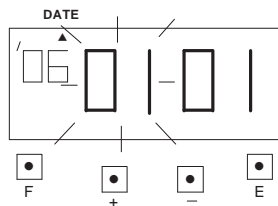

- (2) **Setting the “Month”**

Press the [+] or [-] button to set at “06” and press [E] button. At the same time, the flashing changes from “Month” to “Date”.

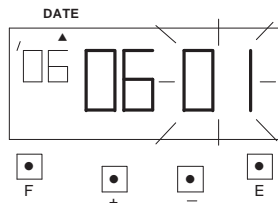

- (3) **Setting the “Date”**

Press the [+] or [-] button to set at “10” and press the [E] button.

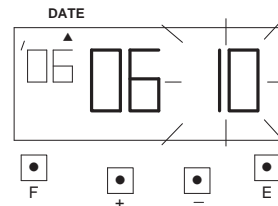

At the same time, the LCD screen only display “▲” under the “Date” mark.

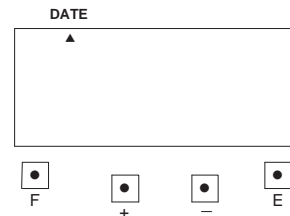

- (4) If you want to set another function, press the [F] button to continue setting. If you finished setting the functions, replace the cover and lock it.

8. SETTING TIME SYSTEM

Time system can be select from 01~02 (see chart below).

	Time System	LCD Display
01	12 hour	PM 6:00
02	24 hour	18:00

If you select 12 hour, for example PM 6:00:
 It will print 06:00P.

Example: Setting the Time system to 24 hour.

- (1) Press the [F] button, and position the “▲” under the “TIME SYSTEM” mark. The “Time system” flashes (The flashing means it can be changed).

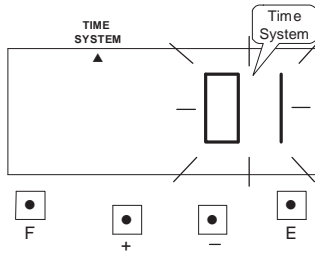

- (3) At the same time, the LCD screen only display “▲” under the “TIME SYSTEM” mark.

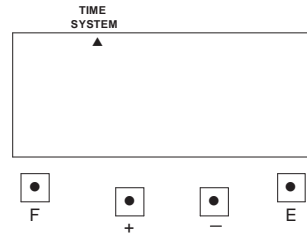

(2) Setting the “Time System”

Press the [+] or [-] button to set at “02” and press [E] button.

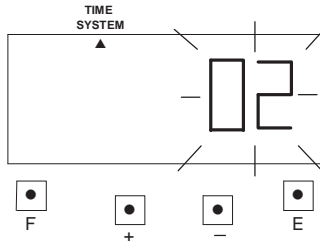

- (4) If you want to set another function, press the [F] button to continue setting. If you finished setting the functions, replace the cover and lock it.

TO PLACE AN ORDER CALL: 866-487-4751
 OR VISIT: WWW.TIMECLOCKEXPERTS.COM

9. SETTING PRINT FORMAT

This function allows you to set, **type of work**, **pay periods** and **pay ending day**.
 *If you try to change the setting, make sure the time recorder has no punch recorded, otherwise the error code "E-49" will appeared. You must make all card resetting or reset all (Please refer card resetting and reset).

Type of work has two modes. You can select employee mode or part-time mode.
 ●Employee mode: calculate the elapse time between IN/OUT punches and prints a running total of accumulated time.
 ●Part-time mode: Pay period only for monthly, prints daily working hours.

Pay periods and pay ending: 3 different formats to suit Monthly, Weekly and Bi-weekly pay. The initial value is on the following table below.

	Pay period	Pay ending
1	Monthly	31
2	Weekly	5
3	Bi-weekly	12

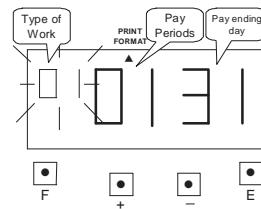

- (1) **Example:** Setting Type of Work is employee, pay period is Monthly,
 Pay ending day is 20.

After the pay ending day, the first punch will on the front side of the time card in the 1'st row. You can punch IN/OUT as many times as required per day.

a. Setting "Type of Work"

Press the [F] button, and position the "▲" under the "PRINT FORMAT" mark. The "Type of work" flashes (The flashing means it can be changed).

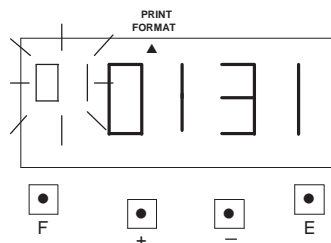

Such as example, press the [E] button because the type of work is not to be changed. At the same time, the flashing changes from "Type of Work" to "Pay Period".

b. Setting "Pay Periods"

Such as example, press the [E] button because the Pay period is not to be changed. At the same time, the flashing changes from "Pay Period" to "Pay ending day".

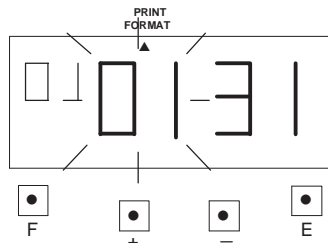

c. Setting the "Pay ending day"

Press the [+] or [-] button to Set at "20" and press [E] button

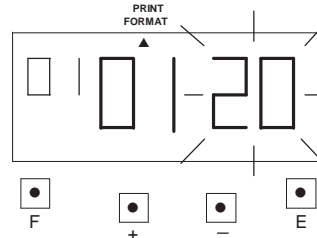

At the same time, the LCD screen only display "▲" under the "PRINT FORMAT" mark.

- d. If you want to set another function, press the [F] button to continue setting. If you finished setting the functions, replace the cover and lock it.

TO PLACE AN ORDER CALL: 866-487-4751
OR VISIT: WWW.TIMECLOCKEXPERTS.COM

- (2) **Example:** Setting Type of Work is employee, pay period is Weekly,
Pay ending day is Friday.

	Today						
Date	May 2	May 3	May 4	May 5	May 6	May 7	May 8
Day of week	Wed.	Thu.	Fri.	Sat.	Sun.	Mon.	Tue.
Code	00	01	02	03	04	05	06

After the pay ending day, your first punch will on the front side of the time card in the 1'st row; you can punch IN/OUT as many times as required per day.

a. Setting "Type of Work"

Press the [F] button, and position the "▲" under the "PRINT FORMAT" mark. The "Type of work" flashes (The flashing means it can be changed).

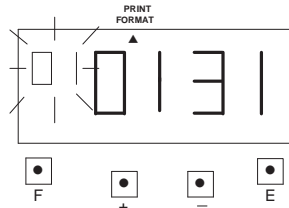

Such as example, press the [E] button because the type of work is not to be changed. At the same time, the flashing changes from "Type of Work" to "Pay Period".

b. Setting "Pay Period"

Press the [+] or [-] button to Set at "2" and press [E] button. At the same time, the flashing changes from "Pay Period" to "Pay ending day".

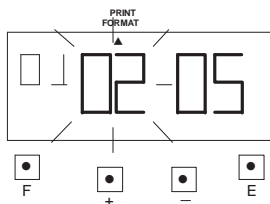

c. Setting the "Pay ending day"

Press the [+] or [-] button to set at "02" and press [E] button.

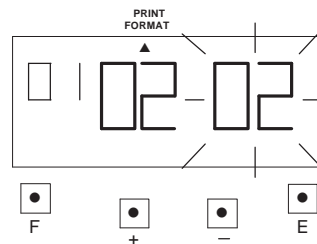

At the same time, the LCD screen only display "▲" under the "PRINT FORMAT" mark.

- d. If you want to set another function, press the [F] button to continue setting. If you finished setting the functions, replace the cover and lock it.

TO PLACE AN ORDER CALL: 866-487-4751
OR VISIT: WWW.TIMECLOCKEXPERTS.COM

(3) Example: Setting Type of Work is employee, pay period is Bi- Weekly,
Pay ending day is following Friday.

Today								
Date	May 2	May 3	~	May 11	May 12	~	May 14	May 15
Day of week	Wed.	Thu.	~	Fri.	Sat.	~	Mon.	Tue.
Code	00	01	~	09	10	~	12	13

After the pay ending day, your first punch will on the front side of the time card in the 1'st row; you can punch IN/OUT as many times as required per day.

a. Setting "Type of Work"

Press the [F] button, and position the "▲" under the "PRINT FORMAT" mark. The "Type of work" flashes (The flashing means it can be changed).

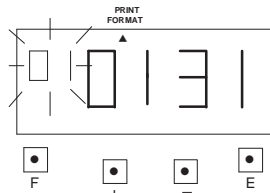

Such as example, press the [E] button because the type of work is not to be changed. At the same time, the flashing changes from "Type of Work" to "Pay Period".

b. Setting "Pay Period"

Press the [+] or [-] button to Set at "3" and press [E] button. At the same time, the flashing changes from "Pay Period" to "Pay ending day".

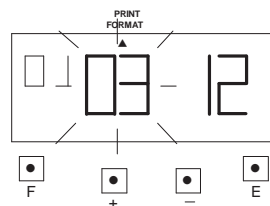

c. Setting the "Pay ending day"

Press the [+] or [-] button to Set at "09" and press [E] button

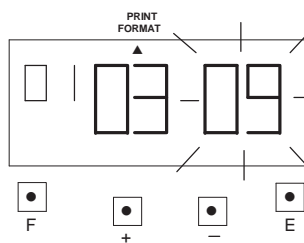

At the same time, the LCD screen only display "▲" under the "PRINT FORMAT" mark.

d. If you want to set another function, press the [F] button to continue setting. If you finished setting the functions, replace the cover and lock it.

(4) Example: Setting Type of Work is part-time, Pay ending day is 20.

*Pay ending day will printed on time card's 32'th row. After the Pay ending day, the first day imprint will be on the time card's 2'nd row.

a. Setting "Type of Work"

Press the [F] button, and position the "▲" under the "PRINT FORMAT" mark. The "Type of work" flashes (The flashing means it can be changed).

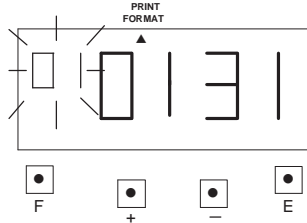

Press the [+] or [-] button to Set at "2" and press [E] button. At the same time, the flashing changes from "Type of Work" to "Pay ending day".

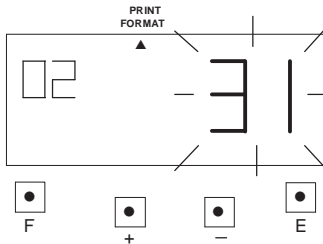

b. Setting the "Pay ending day"

Press the [+] or [-] button to Set at "20" and press [E] button

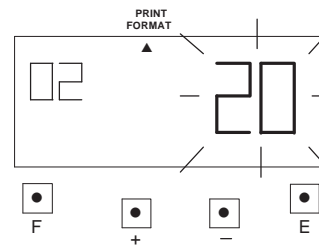

At the same time, the LCD screen only display "▲" under the "PRINT FORMAT" mark.

c. If you want to set another function, press the [F] button to continue setting. If you finished setting the functions, replace the cover and lock it.

10. SETTING THE TIME OF DAY CHANGE

The time of day change refers to the time when the print shift to the next line on a time card for the next day. This function allows the time recorder to imprint the punch out time on the same line of previous working day, even if leaving time is after midnight.

***If you try to change the setting, make sure the time recorder has no punch recorded, otherwise the error code "E-49" will appeared. You must make all card resetting or reset all (Please refer card resetting and reset).**

Example: The time of day change is pre-set on 05:00. Proceed to change the time of day change to be 02:00.

- (1) Press the [F] button, and position the "▲" under the "DAY CHANGE" mark. The "Hour" flashes. (The flashing means it can be changed).

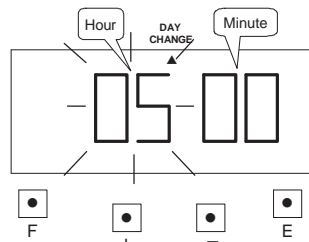

(2) SETTING THE "HOUR"

Press the [+] or [-] button to set at "02" and press [E] button. At the same time, the flashing changes from "Hour" to "Minute".

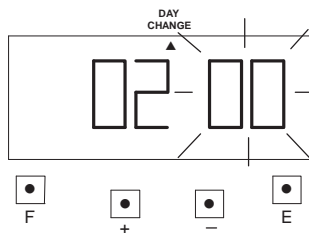

(3) SETTING THE 'MINUTE'

Such as example, press the [E] button because the "Minute" 00 is not to be changed.

At the same time, the LCD screen only display "▲" under the "DAY CHANGE" mark.

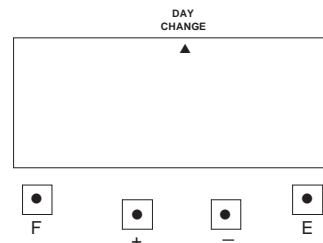

- (4) If you want to set another function, press the [F] button to continue setting. If you finished setting the functions, replace the cover and lock it.

11. SETTING THE COMMON SCHEDULE

This function has 11 items that can be programmed. You may not necessary have to program all of them.

(1) Item define:

Item1 (start): The daily work time start counting.

Item2 (* start): Setting time to start printing special mark (*) for late in or early out.

Item3 (* end): Setting time to cancel printing special mark (*) for late in or early out.

Item4 (end): End time for counting daily work.

Item5 (Max. in value): If you have not set a schedule, you can set the daily work maximum counting hour.

Item6 (Break1 Start): Setting the break1 start time.

Item7 (Break1 End): Setting the break1 end time.

Item8 (Break2 Start): Setting the break2 start time.

Item9 (Break2 End): Setting the break2 end time.

Item10 (Break3 Start): Setting the break3 start time.

Item11 (Break3 End): Setting the break3 end time.

***If you have set a break time(s), the break time(s) will be deducted from the daily work time.**

***If you have set Item5, the setting data of Item1 and Item4 will be deleted.**

***If you have set Item1 or Item4, the setting data of Item5 will be deleted.**

(2) **Example:** Setting the schedule as the following fig. :

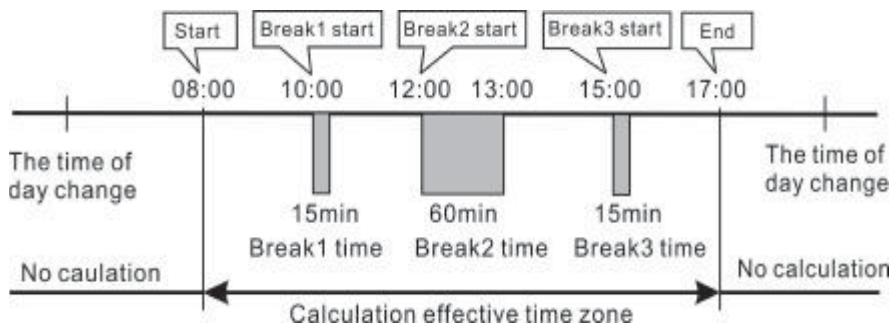

a. Setting the item1 (Start):
Example: the start time is set at 08:00.

(a) Setting the “Item”

Press the [F] button, and position the “▲” under the “COMMON SCHEDULE” mark. The “Item1” flashes (The flashing means it can be changed).

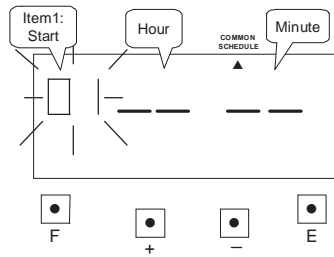

Such as example, press the [E] button because the item is not to be changed. At the same time, the flashing changes from “Item1” to “Hour”.

(b) Setting the “Hour”

Press the [+] or [-] button to set at “08” and press [E] button. At the same time, the flashing changes from “Hour” to “Minute”.

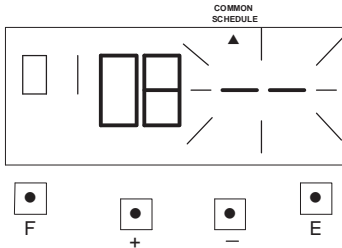

(c) Setting the “Minute”

Press the [+] or [-] button to set at “00” and press [E] button.

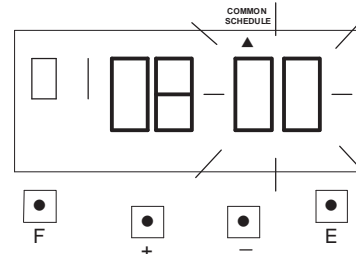

Such as example, the flashing changes from “Minute” to “Item2”.

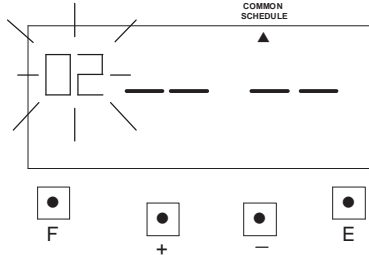

b. Setting the item2 (* Start):

Example: print * start time is set at 08:01.

(a) Setting the “Item”

Press the [F] button, and position the “▲” under the “COMMON SCHEDULE” mark. The “Item” flashes (The flashing means it can be changed).

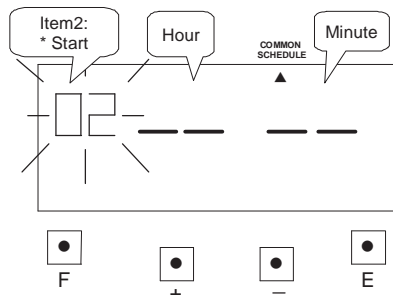

Press the [+] or [-] button to set at “02” and press [E] button. At the same time, the flashing changes from “Item2” to “Hour”.

(b) Setting the “Hour”

Press the [+] or [-] button to set at “08” and press [E] button. At the same time, the flashing changes from “Hour” to “Minute”.

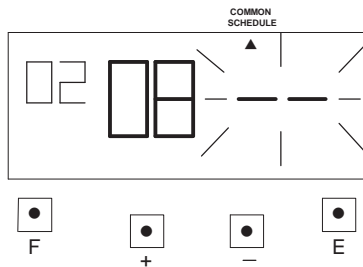

(c) Setting the “Minute”

Press the [+] or [-] button to set at “01” and press [E] button.

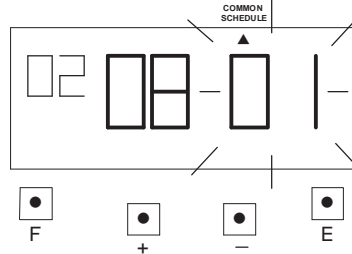

Such as example, the flashing changes from “Minute” to “Item3”.

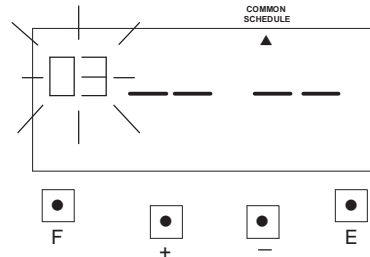

c. Setting the item3 (* End):
Example: print * end time is set at 17:00

(a) Setting the “Item”

Press the [F] button, and position the “▲” under the “COMMON SCHEDULE” mark. The “Item” flashes (The flashing means it can be changed).

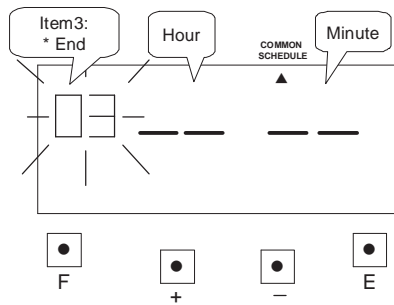

Press the [+] or [-] button to set at “03” and press [E] button. At the same time, the flashing changes from “Item3” to “Hour”.

(b) Setting the “Hour”

Press the [+] or [-] button to set at “17” and press [E] button. At the same time, the flashing changes from “Hour” to “Minute”.

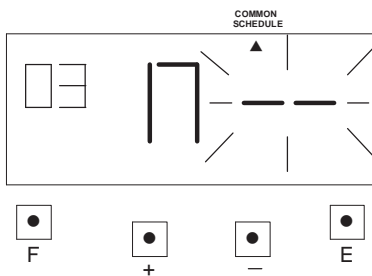

(c) Setting the “Minute”

Press the [+] or [-] button to set at “00” and press [E] button.

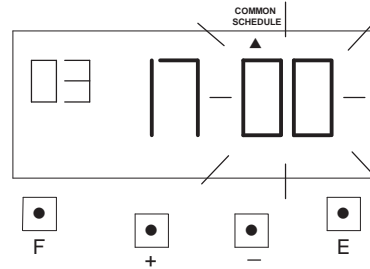

Such as example, the flashing changes from “Minute” to “Item4”.

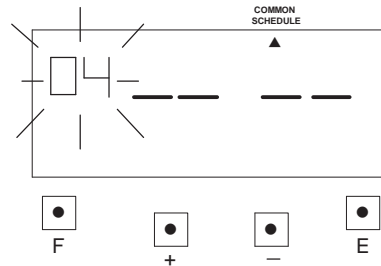

d. Setting the item4 (End):
Example: the end time is set at 17:00.

(a) Setting the “Item”

Press the [F] button, and position the “▲” under the “COMMON SCHEDULE” mark. The “Item” flashes (The flashing means it can be changed).

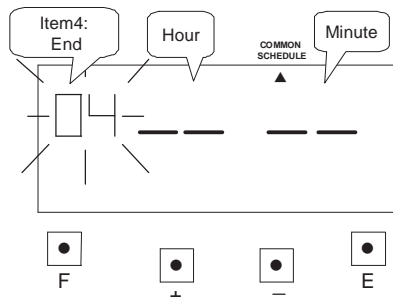

Press the [+] or [-] button to set at “04” and press [E] button. At the same time, the flashing changes from “Item4” to “Hour”.

(b) Setting the “Hour”

Press the [+] or [-] button to set at “17” and press [E] button. At the same time, the flashing changes from “Hour” to “Minute”.

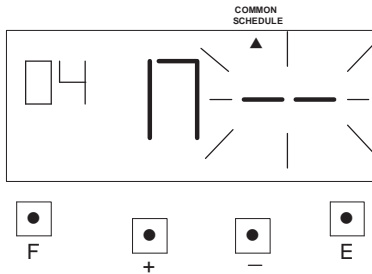

(c) Setting the “Minute”

Press the [+] or [-] button to set at “00” and press [E] button.

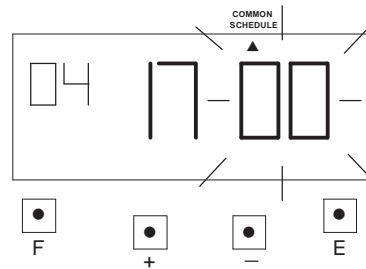

Such as example, the flashing changes from “Minute” to “Item5”.

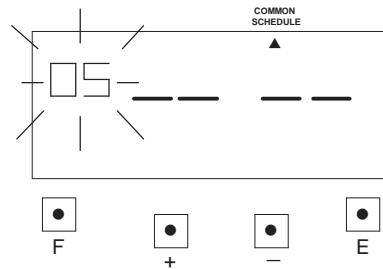

e. Setting the item5 (Max. in value):

Example: maximum in value is set at 12 hours.

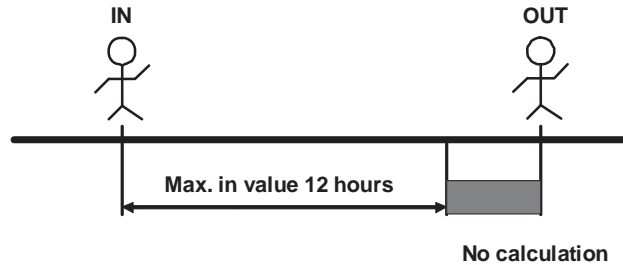

(a) Setting the "Item"

Press the [F] button, and position the "▲" under the "COMMON SCHEDULE" mark. The "Item" flashes (The flashing means it can be changed).

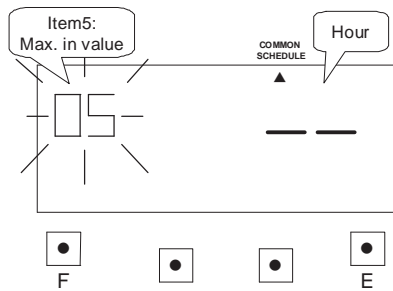

Press the [+] or [-] button to set at "05" and press [E] button. At the same time, the flashing changes from "Item5" to "Hour".

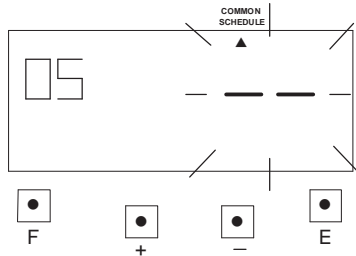

(b) Setting the "Hour"

Press the [+] or [-] button to set at "12" and press [E] button.

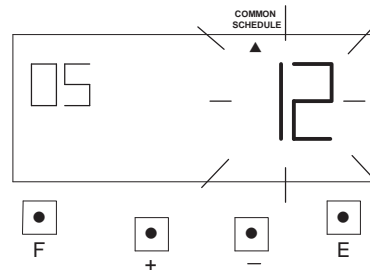

Such as example, the flashing changes from "Hour" to "Item6".

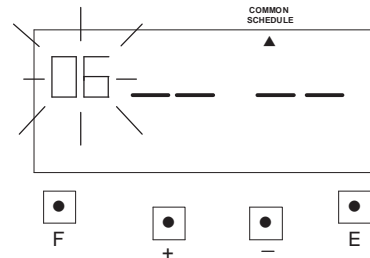

- f. Setting the item6 (Break1 start):
Example: break1 start time is set at 10:00.

(a) Setting the “Item”

Press the [F] button, and position the “▲” under the “COMMON SCHEDULE” mark. The “Item” flashes (The flashing means it can be changed).

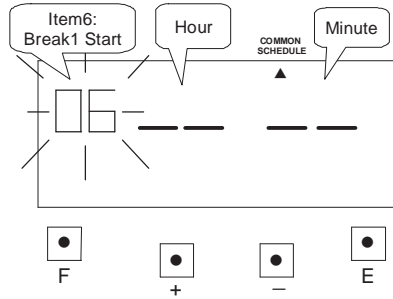

Press the [+] or [-] button to set at “06” and press [E] button. At the same time, the flashing changes from “Item6” to “Hour”.

(b) Setting the “Hour”

Press the [+] or [-] button to set at “10” and press [E] button. At the same time, the flashing changes from “Hour” to “Minute”.

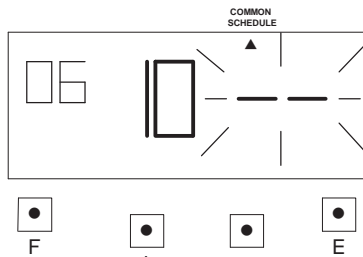

(c) Setting the “Minute”

Press the [+] or [-] button to set at “00” and press [E] button.

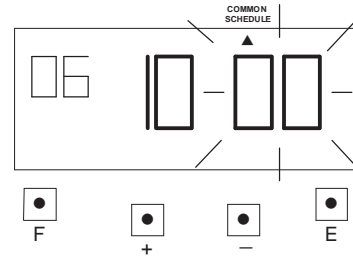

Such as example, the flashing changes from “Minute” to “Item7”.

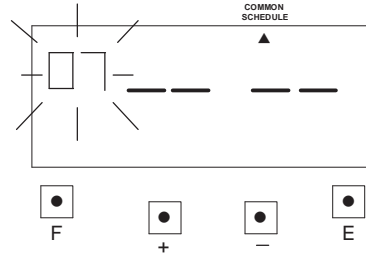

g. Setting the Item7 (Break1 End)

Example: end time for break1 is set at 10:15.

(a) Setting the "Item"

Press the [F] button, and position the "▲" under the "COMMON SCHEDULE" mark. The "Item" flashes (The flashing means it can be changed).

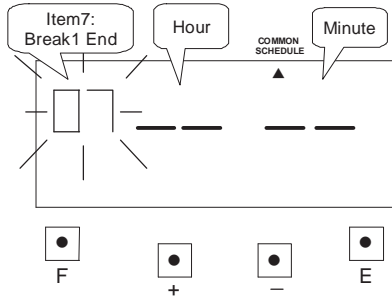

Press the [+] or [-] button to set at "07" and press [E] button. At the same time, the flashing changes from "Item7" to "Hour".

(b) Setting the "Hour"

Press the [+] or [-] button to set at "10" and press [E] button. At the same time, the flashing changes from "Hour" to "Minute".

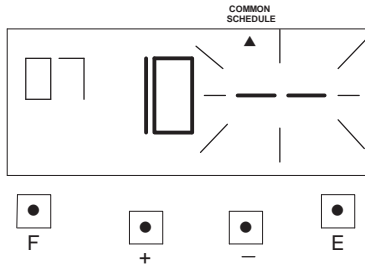

(c) Setting the "Minute"

Press the [+] or [-] button to set at "15" and press [E] button.

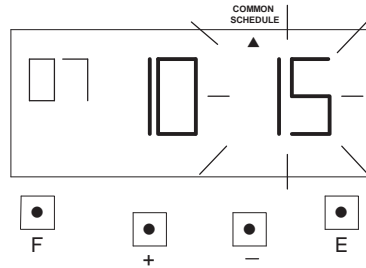

Such as example, the flashing changes from "Hour" to "Item8".

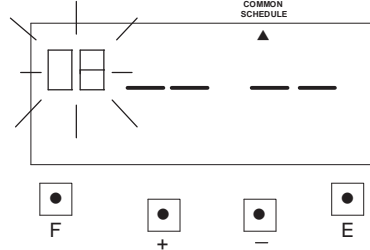

***The settings for break2 start time, break2 end time, break3 start time and break3 end time are the same as break1 start time and break1 end times settings.**

12. SETTING THE EXTRA SCHEDULE

(1) Under the employee mode, you can set up a flexible work schedule time for one particular working day of the week.

a. Item define:

Item1 (Day of the week): One day of the week's schedule to set differently.

Item2 (Start): Extra schedule, start of counting time.

Item3 (* Start): Set time to start printing special mark (*) for late in or early out.

Item4 (* End): Set time to cancel printing special mark (*) for late in or early out.

Item5 (End): Extra schedule, end of counting time.

Item6 (Max. in value): If you have not set a schedule, you can set the extra schedule maximum counting hour.

Item7 (Break1 Start): Setting the break1 start time.

Item8 (Break1 End): Setting the break1 end time.

Item9 (Break2 Start): Setting the break2 start time.

Item10 (Break2 End): Setting the break2 end time.

Item11 (Break3 Start): Setting the break3 start time.

Item12 (Break3 End): Setting the break3 end time.

***If you have set break time(s), the break time(s) will be deducted from the daily work time.**

***If you have set Item6, the setting data of Item2 and Item5 will be deleted.**

***If you have set Item2 or Item5, the setting data of Item6 will be deleted.**

(2) **Example:** Setting the extra schedule as the following fig.:
The extra schedule is on Friday.

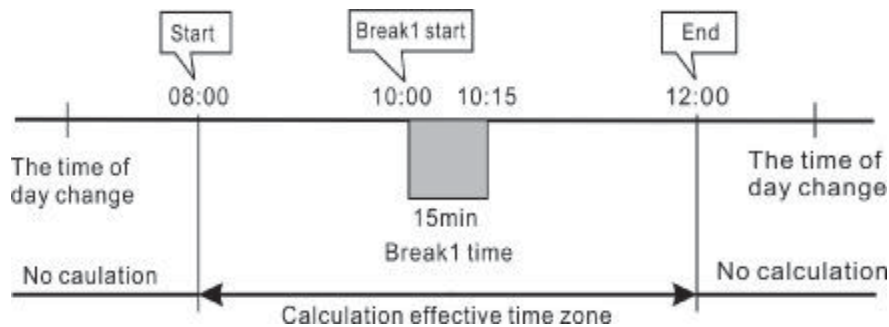

TO PLACE AN ORDER CALL: 866-487-4751
OR VISIT: WWW.TIMECLOCKEXPERTS.COM

a. Setting item1 (select a day of the week):

Day of week	Mon	Tue	Wed	Thu	Fri	Sat	Sun
Code	1	2	3	4	5	6	7

(a) Setting the "Item"

Press the [F] button, and position the "▲" under the "EXTRA SCHEDULE" mark. The "Item1" flashes (The flashing means it can be changed).

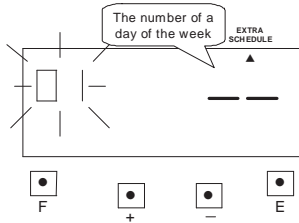

Such as example, press the [E] button because the item is not to be changed. At the same time, the flashing changes from "Item1" to "The number of the day of the week".

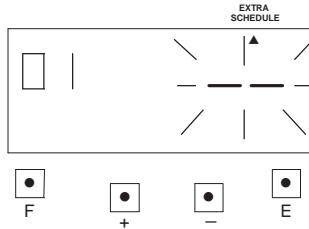

(b) Setting "The day of the week"

Press the [+] or [-] button to set at "05" and press [E] button.

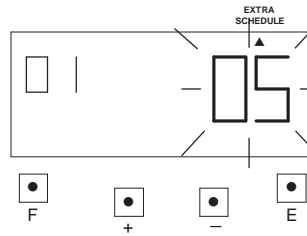

At the same time, the flashing changes from "The number of a day of the week" to "item2".

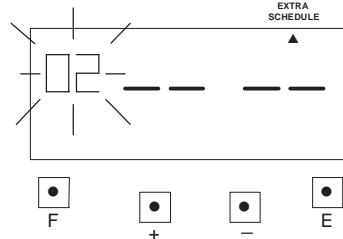

b. Setting the item2 (Start):

Example: the start time is set at 08:00.

(a) Setting the "Item"

Press the [F] button, and position the "▲" under the "EXTRA SCHEDULE" mark. The "Item2" flashes (The flashing means it can be changed).

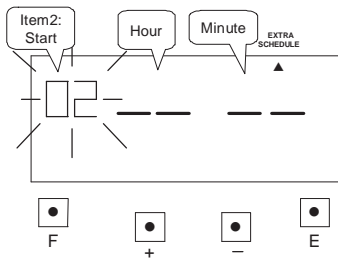

Press the [+] or [-] button to set at "02" and press [E] button. At the same time, the flashing changes from "Minute" to "Hour".

(b) Setting the "Hour"

Press the [+] or [-] button to set at "08" and press [E] button. At the same time, the flashing changes from "Hour" to "Minute".

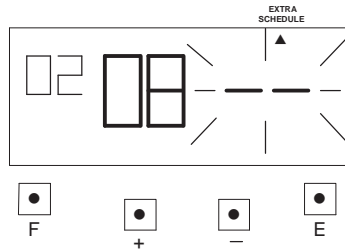

(c) Setting the "Minute"

Press the [+] or [-] button to set at "00" and press [E] button.

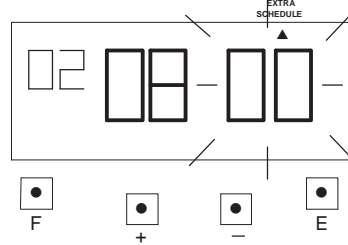

Such as example, the flashing changes from "Minute" to "Item3".

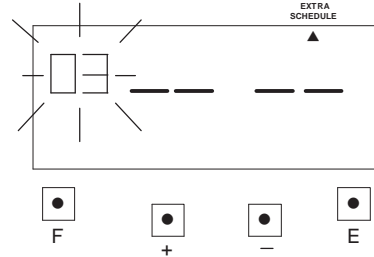

c. Setting the item3 (* Start):

Example: print * start time is set at 08:01.

(a) Setting the “Item”

Press the [F] button, and position the “▲” under the “EXTRA SCHEDULE” mark. The “Item” flashes (The flashing means it can be changed).

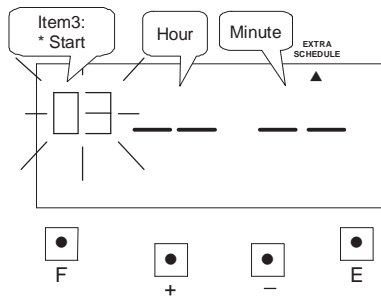

Press the [+] or [-] button to set at “03” and press [E] button. At the same time, the flashing changes from “Item3” to “Hour”.

(b) Setting the “Hour”

Press the [+] or [-] button to set at “08” and press [E] button. At the same time, the flashing changes from “Hour” to “Minute”.

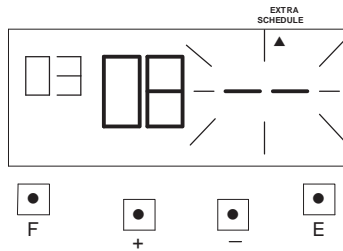

(c) Setting the “Minute”

Press the [+] or [-] button to set at “01” and press [E] button.

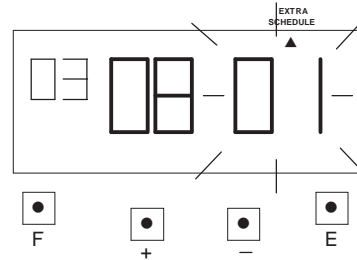

Such as example, the flashing changes from “Minute” to “Item4”.

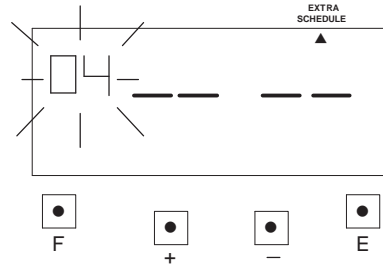

d. Setting the item4 (* End):

Example: print * end time is set at 12:00.

(a) Setting the “Item”

Press the [F] button, and position the “▲” under the “EXTRA SCHEDULE” mark. The “Item” flashes (The flashing means it can be changed).

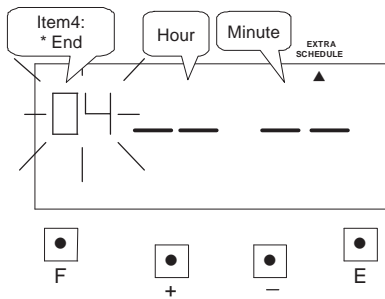

Press the [+] or [-] button to set at “04” and press [E] button. At the same time, the flashing changes from “Item4” to “Hour”.

(b) Setting the “Hour”

Press the [+] or [-] button to set at “17” and press [E] button. At the same time, the flashing changes from “Hour” to “Minute”.

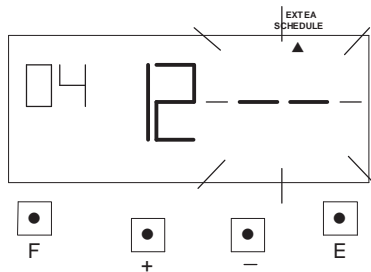

(c) Setting the “Minute”

Press the [+] or [-] button to set at “00” and press [E] button.

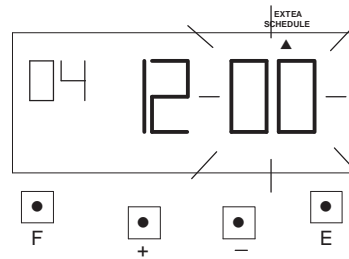

Such as example, the flashing changes from “Minute” to “Item5”.

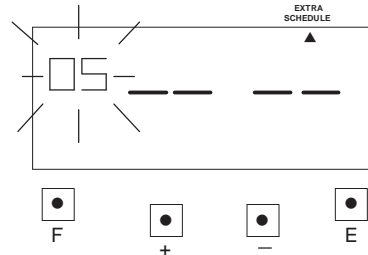

- e. Setting the item5 (End):
Example: the end time is set at 12:00.

(a) Setting the “Item”

Press the [F] button, and position the “▲” under the “EXTRA SCHEDULE” mark. The “Item” flashes (The flashing means it can be changed).

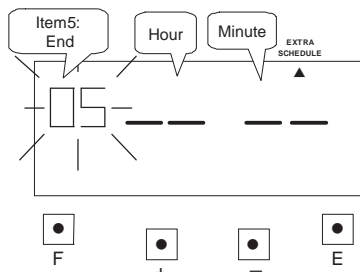

Press the [+] or [-] button to set at “05” and press [E] button. At the same time, the flashing changes from “Item5” to “Hour”.

(b) Setting the “Hour”

Press the [+] or [-] button to set at “17” and press [E] button. At the same time, the flashing changes from “Hour” to “Minute”.

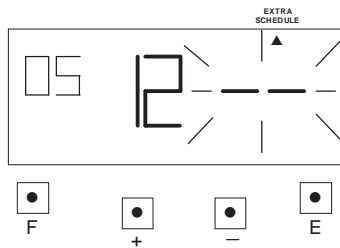

(c) Setting the “Minute”

Press the [+] or [-] button to set at “00” and press [E] button.

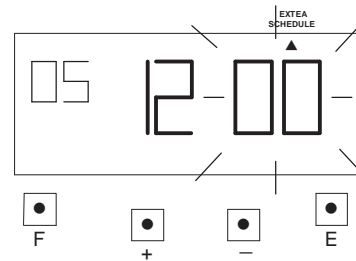

Such as example, the flashing changes from “Minute” to “Item6”.

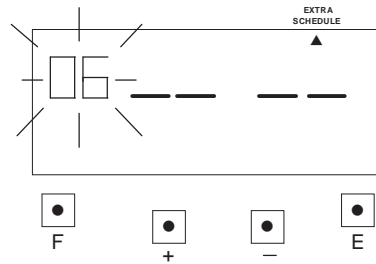

f. Setting the item6 (Max. in value):

Example: maximum in value is set at 6 hours.

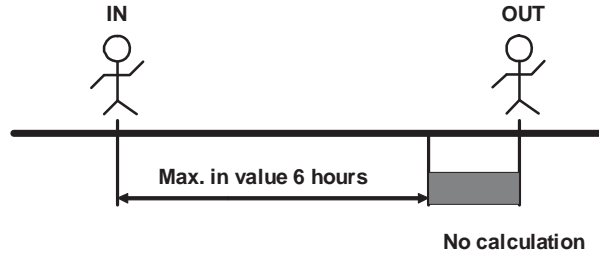

(a) Setting the "Item"

Press the [F] button, and position the "▲" under the "EXTRA SCHEDULE" mark. The "Item" flashes (The flashing means it can be changed).

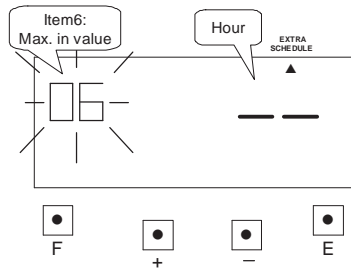

(b) Setting the "Hour"

Press the [+] or [-] button to set at "06" and press [E] button.

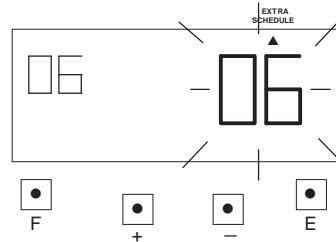

Such as example, the flashing changes from "Hour" to "Item7".

Press the [+] or [-] button to set at "06" and press [E] button. At the same time, the flashing changes from "Item6" to "Hour".

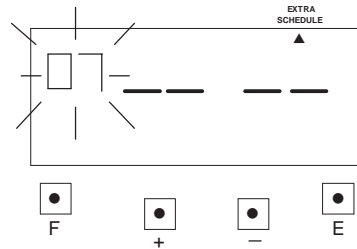
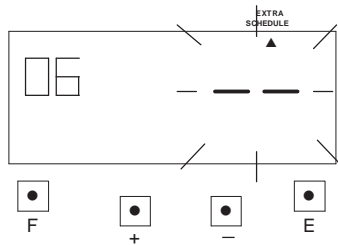

g. Setting the item7 (Break1 Start):
Example: break1 start time is set at 10:00.

(a) Setting the “Item”

Press the [F] button, and position the “▲” under the “EXTRA SCHEDULE” mark. The “Item” flashes (The flashing means it can be changed).

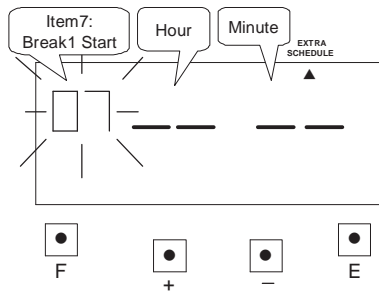

Press the [+] or [-] button to set at “07” and press [E] button. At the same time, the flashing changes from “Item6” to “Hour”.

(b) Setting the “Hour”

Press the [+] or [-] button to set at “10” and press [E] button. At the same time, the flashing changes from “Hour” to “Minute”.

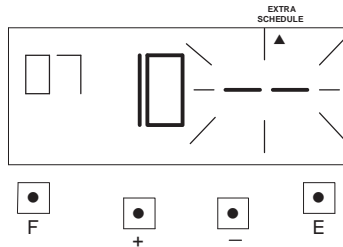

(c) Setting the “Minute”

Press the [+] or [-] button to set at “00” and press [E] button.

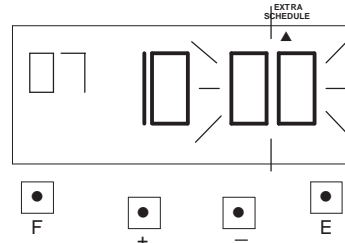

Such as example, the flashing changes from “Minute” to “Item8”.

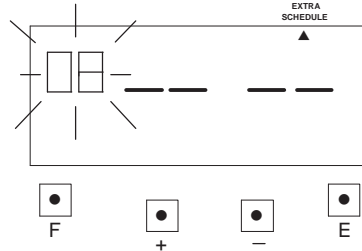

h. Setting the Item8 (Break1 End)

Example: break1 end time is set at 10:15.

(a) Setting the “Item”

Press the [F] button, and position the “▲” under the “EXTRA SCHEDULE” mark. The “Item” flashes (The flashing means it can be changed).

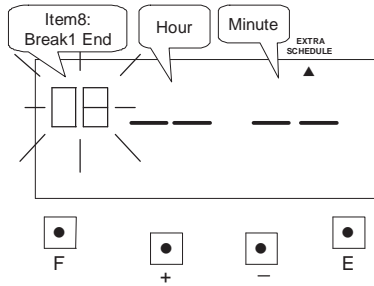

Press the [+] or [-] button to set at “08” and press [E] button. At the same time, the flashing changes from “Item7” to “Hour”.

(b) Setting the “Hour”

Press the [+] or [-] button to set at “10” and press [E] button. At the same time, the flashing changes from “Hour” to “Minute”.

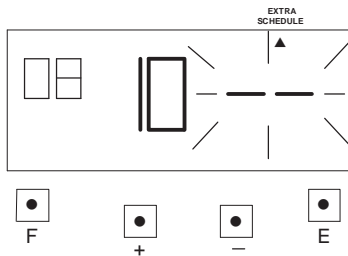

(c) Setting the “Minute”

Press the [+] or [-] button to set at “15” and press [E] button.

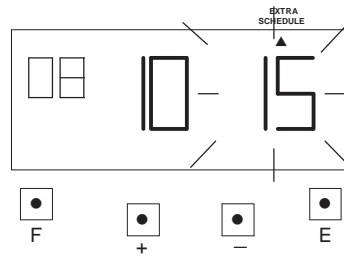

Such as example, the flashing changes from “Hour” to “Item9”.

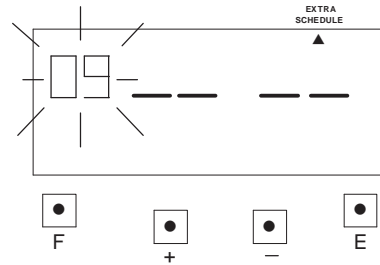

***The settings for break2 start time, break2 end time, break3 start time and break3 end time are the same as break1 start time and break1 end time settings.**

(3) Under the part-time mode

a. Item define:

item1: Setting the working hours and requiring a break time.

Item2: Setting the break time deduction hours.

Example: Setting the working hours 7:30 with a break time of 30 minutes.

b. Setting the item1 (working hours)

(a) Setting the "Item"

Press the [F] button, and position the "▲" under the "EXTRA SCHEDULE" mark. The "Item1" flashes (The flashing means it can be changed).

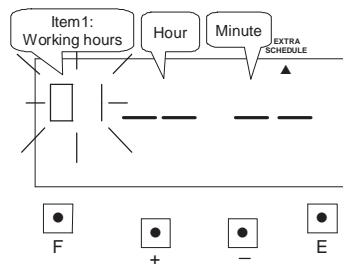

Such as example, press the [E] button because the item is not to be changed. At the same time, the flashing changes from "Item1" to "Hour".

(b) Setting the "Hour"

Press the [+] or [-] button to set at "07" and press [E] button. At the same time, the flashing changes from "Hour" to "Minute".

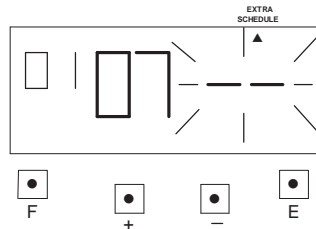

(c) Setting the "Minute"

Press the [+] or [-] button to set at "30" and press [E] button.

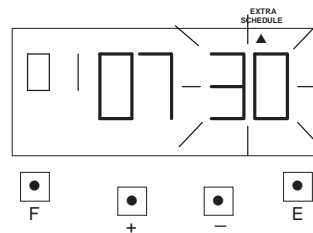

Such as example, the flashing changes from "Hour" to "Item2".

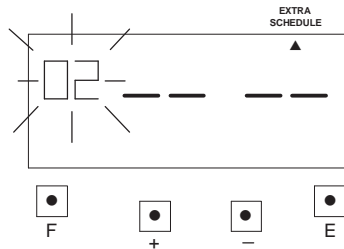

b. Setting the item2 (break time)

(a) Setting the "Item"

Press the [F] button, and position the "▲" under the "EXTRA SCHEDULE" mark. The "Item2" flashes (The flashing means it can be changed).

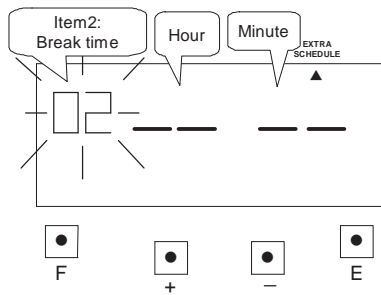

Press the [+] or [-] button to set at "02" and press [E] button. At the same time, the flashing changes from "Item2" to "Hour".

(b) Setting the "Hour"

Press the [+] or [-] button to set at "00" and press [E] button. At the same time, the flashing changes from "Hour" to "Minute".

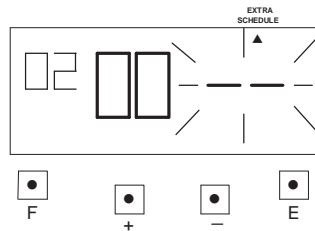

(c) Setting the "Minute"

Press the [+] or [-] button to set at "30" and press [E] button.

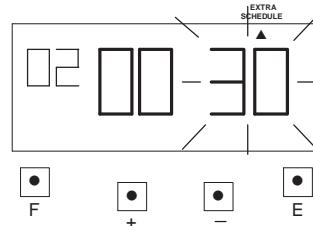

At the same time, the LCD screen only display "▲" under the "EXTRA SCHEDULE" mark.

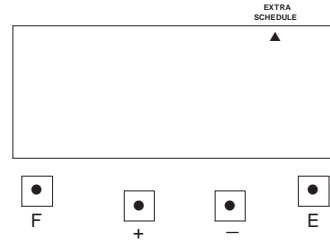

TO PLACE AN ORDER CALL: 866-487-4751
 OR VISIT: WWW.TIMECLOCKEXPERTS.COM

13. SETTING THE ROUNDING PUNCH

In this function, you can select the types of rounding and set the rounding unit.

*If you need to change the setting, make sure the time recorder has no punch recorded, otherwise the error code "E-49" will appeared. You must make all card resetting or reset all (Please refer card resetting and reset).

Types of rounding:

Types of rounding	Punch	Hours
Code	01	02

Rounding unit:

Rounding unit									
1min.	3min.	5min.	6min.	10min.	12min.	15min.	20min.	30min.	60min.

Types of rounding: "Punch" and "Rounding unit" is 20 minutes.

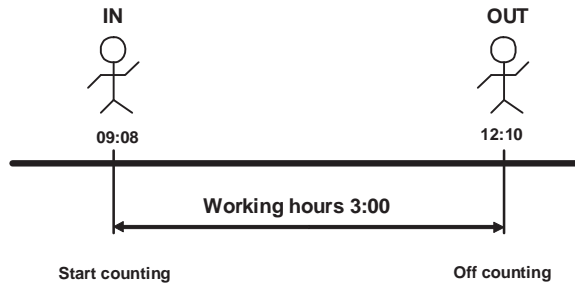

Types of rounding: "Hours" and "Rounding unit" is 20 minutes.

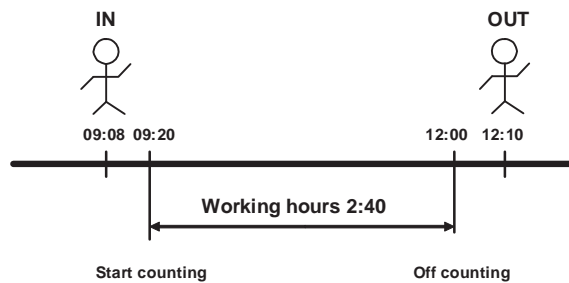

Example: Types of rounding: “Punch” and “Rounding unit” is 20 minutes.

- (1) Press the [F] button, and position the “▲” next the “ROUNDING PUNCH” mark. The flashing digit indicates “Types of rounding” (The flashing means it can be changed).

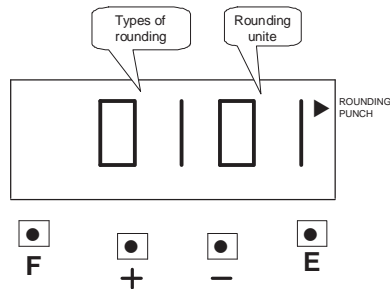

- (2) **Setting the “Types of rounding”**
Such as example, Press the [+] or [-] button to set at “02”, and then press the [E] button. At the same time, the flashing changes from the “Types of rounding” to “Rounding unit”.

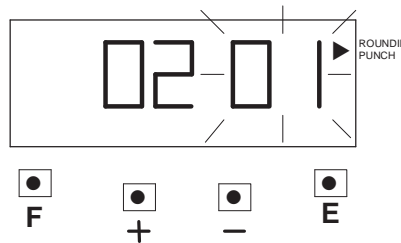

- (3) **Setting the “Rounding unit”**
Such as example, Press the [+] or [-] button to set at “20”, and then press the [E] button.

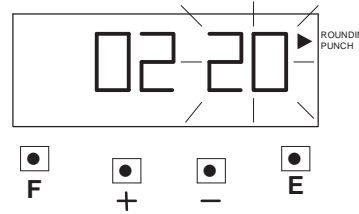

At the same time, the LCD screen only display “▲” next the “ROUNDING PUNCH” mark.

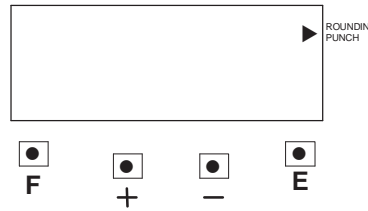

- (4) If you want to set another function, press the [F] button to continue setting. If you finished setting the functions, replace the cover and lock it.

TO PLACE AN ORDER CALL: 866-487-4751
OR VISIT: WWW.TIMECLOCKEXPERTS.COM

14. SETTING THE DAYLIGHT SAVING TIME

* At 2:00 AM on the first day of summer time, the clock automatically gains one hour to show 3:00 AM.

At 3:00 AM on the last day of summer time, the clock automatically loses one hour to show 2:00 Am.

SETTING THE DAYLIGHT SAVING TIME

Example:

The first day of summer time: Sunday, March 25, 2007.

The last day of summer time: Sunday, September 30, 2007.

If set as the above, the unit remembers the start date as the last Sunday of March and the end date as the last Sunday of October.

Once set, the unit automatically updates the setting every year thereafter. No further manual setting is necessary.

Note: Two programs (starting and ending day) that must be set.

- (1) Press the [F] button and position the “▲” next to the “DAYLIGHT SAVING TIME” mark. (The flashing means it can be changed.)

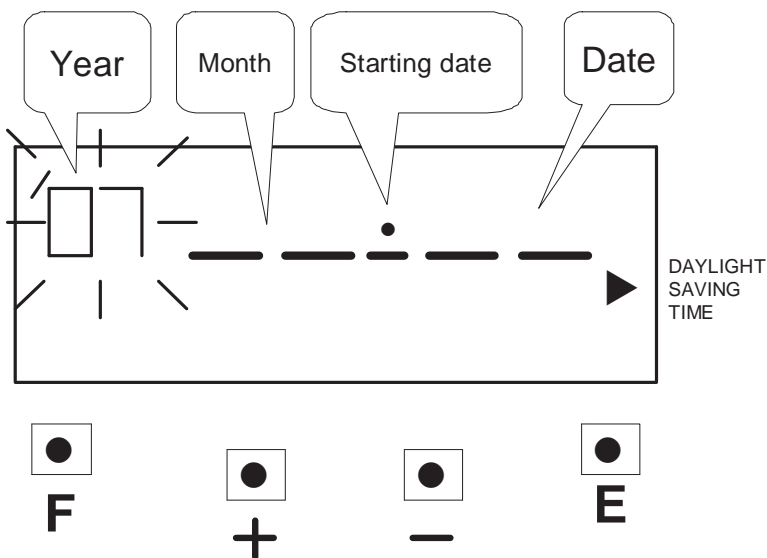

Set the starting date

(2) Setting the "Year"

Such as example, press the [E] button because the year 2007 is not to be changed.

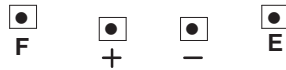
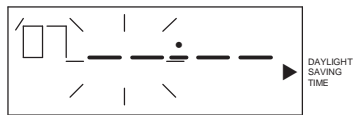

At the same time, the flashing changes from "Year" to "Month"

(4) Setting the "Date"

Press the [+] or [-] button to set at "25", and press the [E] button.

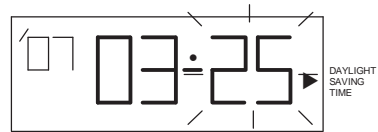

After a few seconds, go on to set "the ending date"

(3) Setting the "Month"

Press the [+] or [-] button to set at "03", and press the [E] button.

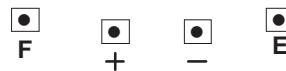
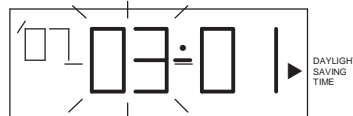

At the same time, the flashing changes from "Month" to "Date"

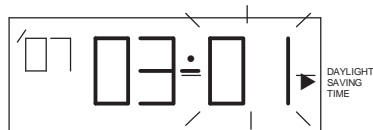
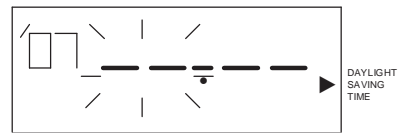

Set the ending date

(5) Setting the "Year"

Such as example, press the [E] button because the year 2007 is not to be changed.

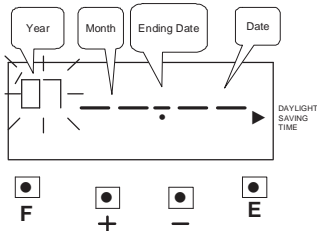

At the same time, the flashing changes from "Year" to "Month"

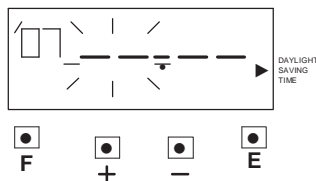

(6) Setting the "Month"

Press the [+] or [-] button to set at "09", and press the [E] button.

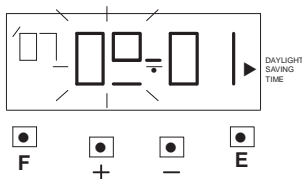

At the same time, the flashing changes from "Month" to "Date"

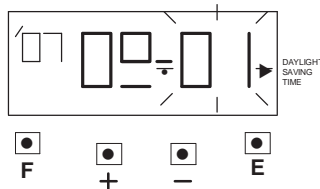

(7) Setting the "Date"

Press the [+] or [-] button to set at "30", and press the [E] button.

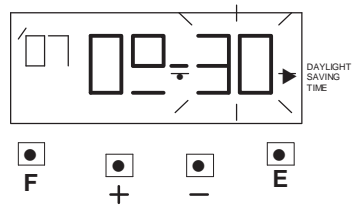

At the same time, the LCD screen only display "▲" next to "DAYLIGHT SAVING TIME" mark.

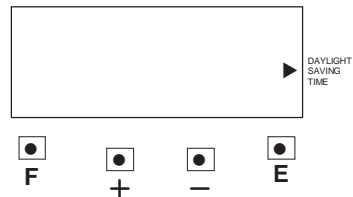

- (8) If you want to set another function, press the [F] button to continue setting. If you finished setting the functions, replace the cover and lock it.

Deleting the Daylight Saving Time setting

To delete the daylight saving time setting, change the displayed starting "month" setting to "- -".

Example: To delete the daylight saving time setting.

- (1) Press the [F] button and position the "▲" next to the "DAYLIGHT SAVING TIME" mark (The flashing means it can be changed).

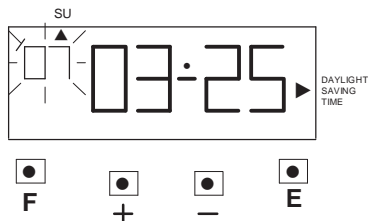

- (2) Press the [E] button, and then the flashing changes from "Year" to "Month"

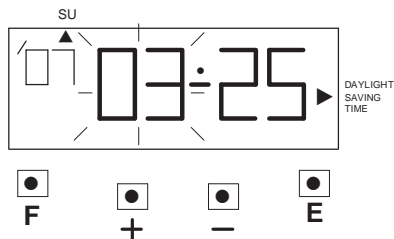

- (3) Press the [+] or [-] button to set the "Month" and "Date" at "-- --".

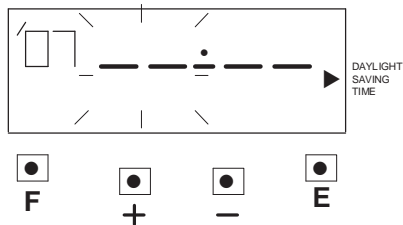

- (4) Press the [E] button twice. At the same time, the LCD screen the flashing changes from "Date" to "Year" the daylight saving time setting has been deleted.

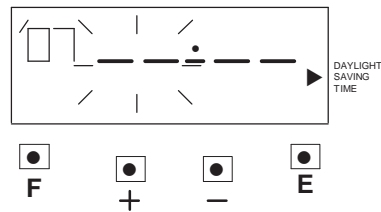

15. SETTING THE PRINT LANGUAGE

If pay periods was selected in Weekly or Bi-weekly, the date of imprint will print the language for day of the week. Initial value of the language is 01.
Example: Change Date of imprint from 01 to 02.

Date imprint	Example : Thursday 5:00 p.m.
01. English	TH 05:00P
02. Spanish	JU 05:00P
03. German	DO 05:00P
04. French	JE 05:00P
05. Italian	GI 05:00P
06. Portuguese	QI 05:00P

- (1) Press the [F] button, and position the "▲" next the "LANGUAGE" mark. The flashing digit indicates "Date Imprint Options" (The flashing means it can be changed).

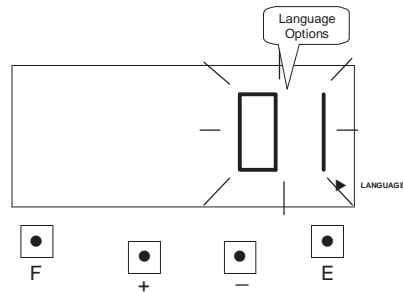

- (2) Such as example, press the [+] or [-] button to set at "2", and then press [E] button. At the same time, the LCD screen only display "▲" under the "DATE IMPRINT" mark.

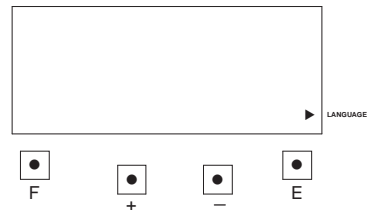

- (3) If you want to set another function, press the [F] button to continue setting. If you finished setting the functions, replace the cover and lock it.

16. SETTING THE BUZZER PERIOD

Buzzer period feature is only available when setting common schedule (start, end, break time start and end) and extra schedule (start, end, break time start and end). This function is to set the duration of External Time Signal (Option) and Built-in Melody. The buzzer duration period, 1 through 59 seconds, can be selected.

* The optional siren/bell relay pc board must be connected to the time recorder.

Example: Setting the External Time signal to 10 seconds and Built-in Melody to 15 seconds.

- (1) Press the [F] button, and position the “▲” over the “BUZZER PERIOD” mark. The flashing digit indicates “EXTERNAL SIGNAL” (The flashing means it can be changed).

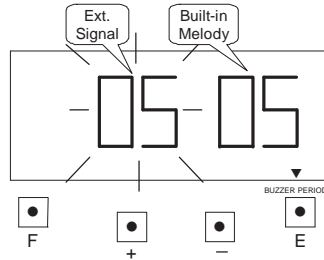

- (2) **Setting the durations of “Ext. Signal”**

Such as example, Press the [+] or [-] button to set at “10”, and then press the [E] button.

At the same time, the flashing changes from the “External Signal” to “Built-in Melody”.

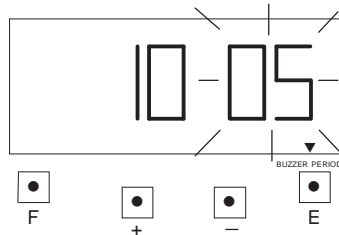

- (3) **Setting the durations of “Built-in Melody”**

Such as example, Press the [+] or [-] button to set at “15”, and then press the [E] button.

At the same time, the LCD screen only display “▲” under the “BUZZER PERIOD” mark.

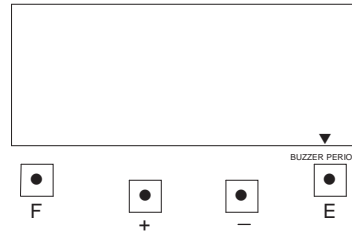

- (4) If you want to set another function, press the [F] button to continue setting. If you finished setting the functions, replace the cover and lock it.

17. SETTING THE VERTICAL ADJUST

If the printing is off the center of the row, you can use this function to adjust it. Increase the value +1 will print upwards 0.375mm, decrease the value -1 will print downwards 0.375mm.

Example: Print position upwards 0.75mm. Requiring to change the value to 02.

- (1) Press the [F] button, and position the “▲” under the “VERTICAL ADJUST” mark. The flashes digit indicates “Vertical adjust options” (The flashing means it can be changed).
- (2) If you want to set another function, press the [F] button to continue setting. If you finished setting the functions, replace the cover and lock it.

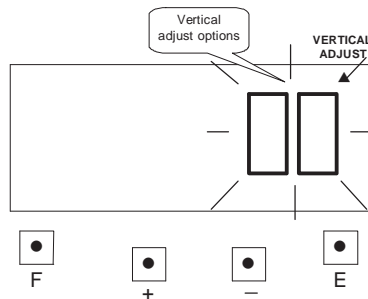

Such as example, Press the [+] or [-] button to set at “2”, and then press the [E] button. At the same time, the LCD screen only display “▲” under the “VERTICAL ADJUST” mark.

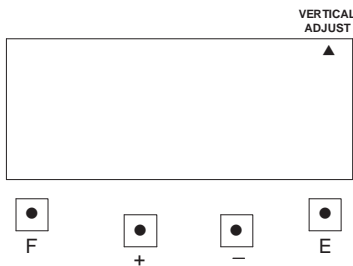

18. TIME CARD NUMBER TRANSFER

When the time card is damaged, lost or fully printed before the pay ending day, you can use this function to make a new card number to replace the old card number.

Example: Transfer from Time card No. 5 to Time card No. 25.

- 1) Open the cover then press both the "F" button and "+" button. The number of cards used will be shown on the LCD display.

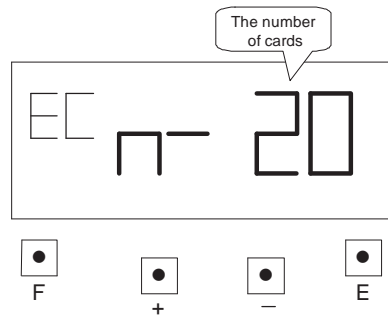

- 2) Press the "+" or "-" button to 005 (card number) then press "E" button.

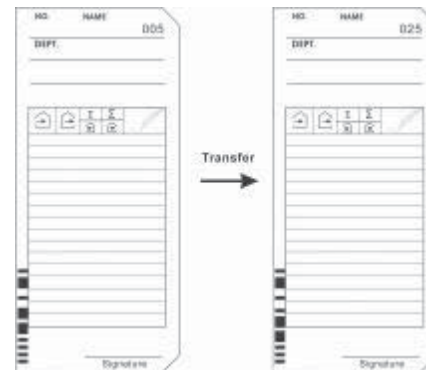
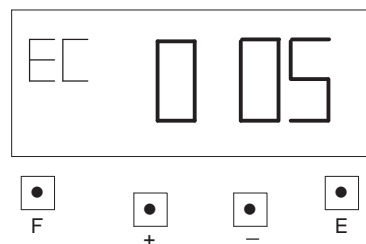

- 3) Insert the time card No. 25 or press the "+" or "-" button to 025 (card number) then press "E" button. The card number is changed, this mode is complete.

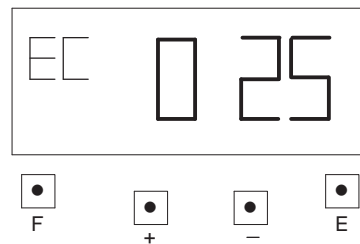

19. TIME CARD NUMBER DELETE

When you want to delete a time card data or all the time cards data in time recorder, you can use this function.

Example: to delete time card No. 12.

- 1) Open the cover then press both the "F" button and "-" button. The number of cards used will be shown on LCD display.
- 3) If you want to delete all the time card data, press the "+" or "-" button to ALL, then press "E" button.

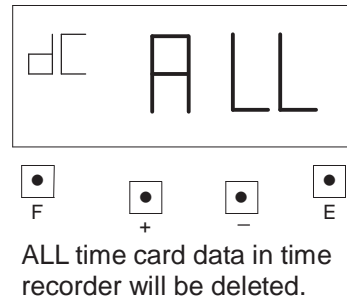
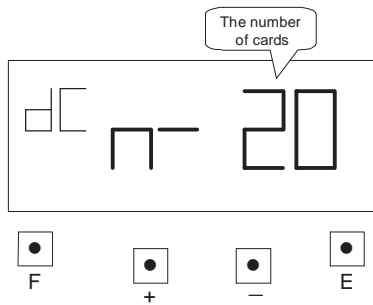

- 2) Press the "+" or "-" button to 012 (card number) then press "E" button.

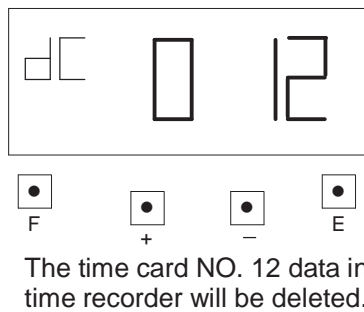

20. PRINT SAMPLE

(1) Part-time mode

Example 1:

- Print format: Part-time mode, pay ending day 25th.
- Time system: 24 hours.
- Printing line: 5:00.
- Rounding: Hourly/Rounding unit 20 minutes.
- Common schedule: Work start: 8:00, Work end: 17:00, at 8:01, * off: 17:00, Break time 12:00~13:00.

	In	Out	Working Hours	Total	
			Σ	Σ	
Month					
Date	03	7:52	17:06	8:00	8:00
Special mark "***"	8:22*	15:52*	6:00	14:00	
Early out	17:56	20:00	0:00	14:00!	Caution Mark "!" Because caculation results is "0:00"
Special mark "***"					
Late in	7:45	15:30*	6:20	20:20	
	04 - 8:06*	17:10	7:40	28:00	

Part-time Hourly

TO PLACE AN ORDER CALL: 866-487-4751
OR VISIT: WWW.TIMECLOCKEXPERTS.COM

Example 2:

- Print format: Part-time mode, pay ending day 25th.
- Time system: 12 hours.
- Printing line: 5:00.
- Rounding: Punch/Rounding unit 20 minutes.
- Common schedule: Work start: 8:00, Work end: 17:00, at 8:01, * off: 17:00, Break time 12:00~13:00.

	In	Out	Working Hours	Total	
			Σ	Σ	
AM					
	03 7:52A	05 5:06P	8:00	8:00	
PM	07 8:22*	07 15:52±	6:20	14:20	
	23 5:56P	08 8:00P	0:00	14:20!	
	05 7:45A	05 3:30±	6:20	20:40	
	04 8:06*	05 5:10P	7:40	28:20	

Part-time Punch

TO PLACE AN ORDER CALL: 866-487-4751
 OR VISIT: WWW.TIMECLOCKEXPERTS.COM

(2) Employee mode:

Example 1

- Print format: Employee mode, weekly, pay ending day Tuesday.
- Time system: 12 hours.
- Printing line: 8:00.
- Rounding: Hourly/Rounding unit 15 min.
- Common schedule: Break time 12:00~13:00.

In	Out	Working Hours	Total	
		Σ	Σ	
03W: 9:52A	W: 12:06P	2:00	2:00	
W: 1:22P	W: 4:52P	3:15	5:15	
W: 5:56P	W: 8:00P	2:00	7:15	
F: 6:50P	S: 7:08A	11:00	18:15	
S: 6:55P	S: 7:03A	10:00s	28:15!	
04T: 8:06A	T: 9:30A	1:15	29:30	
T: 1:31P	T: 3:33P	1:45	31:15	

Caution mark"!"
 Because Summer
 time start

Employee Hourly

TO PLACE AN ORDER CALL: 866-487-4751
 OR VISIT: WWW.TIMECLOCKEXPERTS.COM

Example 2

- Print format: Employee mode, weekly, pay ending day Tuesday.
- Time system: 24 hours.
- Printing line: 8:00.
- Rounding: Punch/Rounding unit 15 min.
- Common schedule: Break time 12:00~13:00.

	In	Out	Working Hours	Total	
			Σ	Σ	
03	9:52	12:06	2:00	2:00	
	13:22	15:52	2:30	4:30	
	17:56	20:00	2:00	6:30	
	18:50	7:08	11:15	17:45	
	18:55	7:03	10:00s	27:45!	
04	8:06	9:30	1:15	29:00	
	13:31	15:33	2:00	31:00	

Employee Punch

TO PLACE AN ORDER CALL: 866-487-4751
OR VISIT: WWW.TIMECLOCKEXPERTS.COM

21. RESET

- Press this switch when operation has become abnormal. Operation will return to normal without affecting the present time and program memory.
- If abnormal display or operation should persist even after Reset switch is pressed, press Reset switch and E button at the same time, then release reset switch first, then release the E button, the program will return to the factory defaults. Once this is done, you will need to reprogram the unit to your own requirements again.

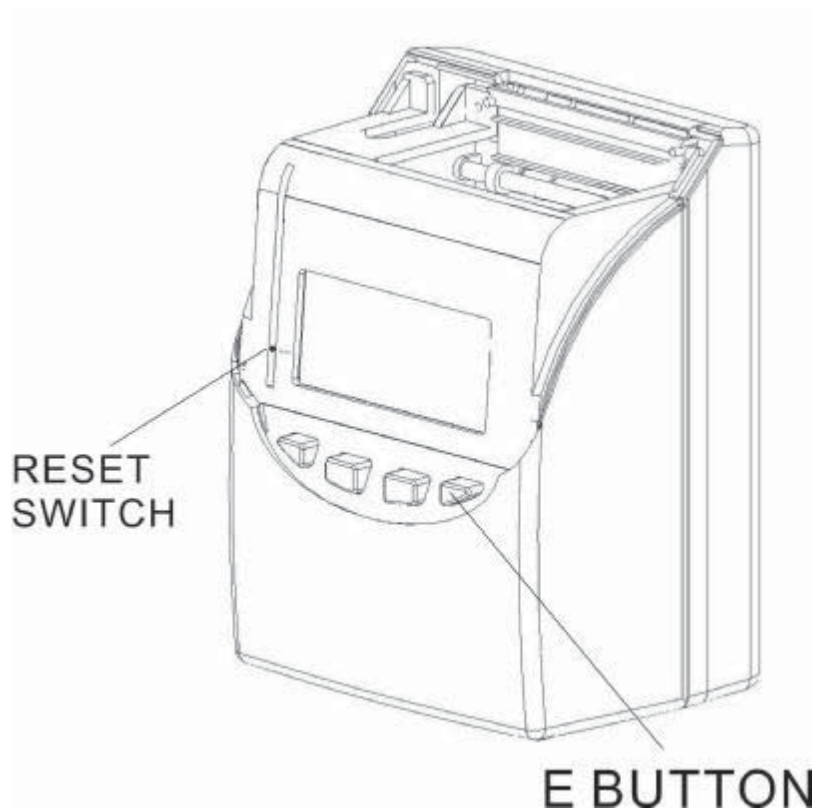

TO PLACE AN ORDER CALL: 866-487-4751
OR VISIT: WWW.TIMECLOCKEXPERTS.COM

22. REPLACING THE RIBBON CARTRIDGE

- (1) Unlock the key and remove the cover.

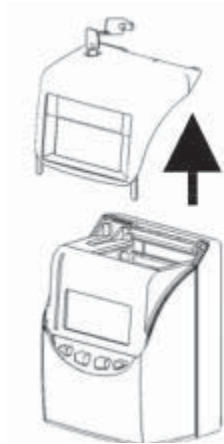

- (2) Hold the ribbon cartridge by its tab and pull up to remove it.

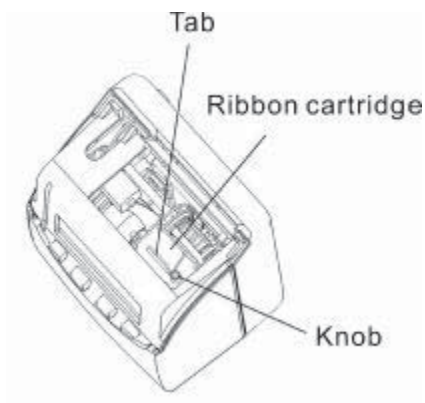

- (3) Turn the knob of the new cartridge in direction of the arrow (clockwise) to tighten the ribbon.



Installing the ribbon cartridge so that the ribbon is between the print head and ribbon mask.

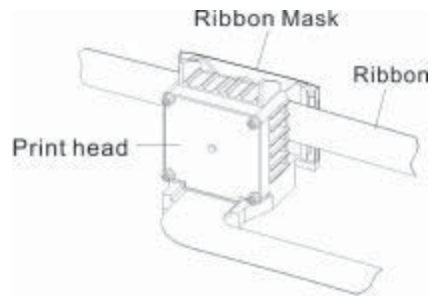

Turn the knob of the cartridge in the direction of the arrow to tighten the ribbon.
Then replace the cover and lock.



TO PLACE AN ORDER CALL: 866-487-4751
OR VISIT: WWW.TIMECLOCKEXPERTS.COM

23. CONNECTING THE EXTERNAL TIME SIGNAL (OPTIONAL)

- (1) Unlock the key and remove the cover.

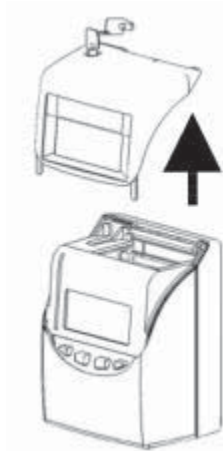

- (3) Install the External time signal PC Board inside the front case. Then attach the connecting cable from the Ext. PC Board to the connector on the Main PC Board.

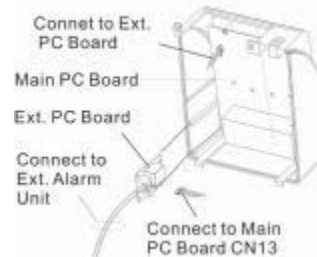

- (2) Use a screw driver to release the two screws at the top then, detach the front of case from the back case.

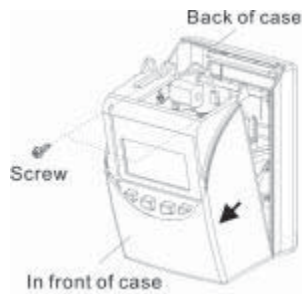

- (4) Rejoin the front case to the back case, then re-screw the two screws back into place.

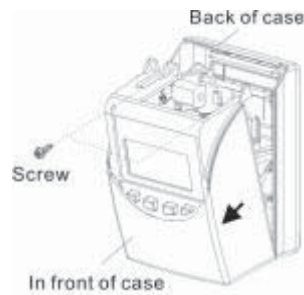

Then replace the cover and lock.



TO PLACE AN ORDER CALL: 866-487-4751
OR VISIT: WWW.TIMECLOCKEXPERTS.COM

24. INSTALLING THE BATTERY PACK (OPTIONAL)

- (1) Push the centre of the lid upwards and then remove the lid from the two clasps.

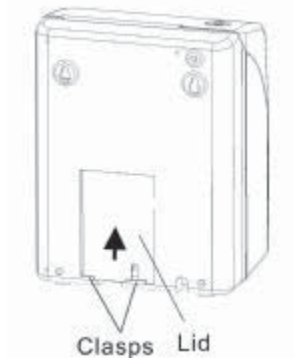

- (3) Insert the battery pack into the time recorder as show in the figure.



- (2) Attach the battery connector to the connector from the clock.

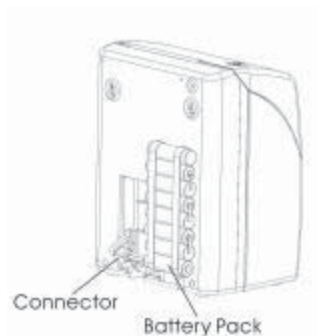

- (4) Insert the lid into the slot, keep pressing it down until it hooks to the clasp.

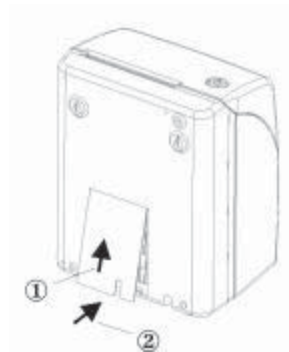

*When replacing the Lid, make sure the cord is not caught.

25. TROUBLESHOOTING

- (1) The time recorder does not work and LCD shows no display.
 - 1) Ensure the power code is properly plugged into the AC outlet.
 - 2) Check for blown fuse on the main PC board (F1).
- (2) The time recorder has become abnormal
Press the Reset switch.
*Please refer to page 34.
- (3) Printing on the time card is not in accordance to the L.C.D. display time.
Check card detection card sensor.
- (4) Memory is not being kept after power failure.
Check if the lithium battery (**BAT1** on main PC board) is faulty.
- (5) The printing position is incorrect.
Setting of pay ending date is not correct. Please set them correctly.
- (6) Light printing.
 - a. The ribbon is worn out, please replace the ribbon cassette.
 - b. The ribbon cassette is not installed correctly, please reinstall it.
- (7) List of error codes:
 - a. E-01: The remaining life of lithium battery for memory back-up is short.
 - b. E-30: Vertical motor can not run or Vertical motor counter sensor is not normal.
 - c. E-31: Horizontal motor can not run or Horizontal motor counter sensor is not normal.
 - d. E-32: The time card is jammed.
 - e. E-33: The sensor unit (Bottom sensor) is not normal.
 - f. E-37: The front or back of the time card is inserted incorrectly.
 - g. E-38: Check the print head "home position" sensor.
 - h. E39: The time card is damaged.
 - i. E-40: Input incorrect data.
 - j. E-41: The start day and end day of daylight saving time is the same date.
 - k. E-49: The card transfer error, maybe the new card number is in used.
 - l. E-50: Input incorrect data (for technicians only)
 - m. E-51: The time card was inserted within one minute after the last punch.
 - n. E-53: Over 50 time cards are used.
 - o. End: The time card is fully printed before pay ending day, must use card transfer function to make a new card to replace the old card.